

ABSTRACT: Proper modeling of the shear walls is very important for both linear and nonlinear analyses of building structures. In linear analyses of structures, Reinforced concrete (RC) shear walls are modeled utilizing different techniques either using shell elements or combination of frame elements. In the nonlinear analyses, the nonlinear material model of mid-pier frame is generally based on plastic hinge concept located on the plastic zones at the end of the structural elements or distributed along the member span length. The nonlinear behavior of the shell elements is generally modeled using multi layer shell element with layered material model. In this approach, the concrete and the reinforcement inside the structural elements are modeled respectively with different layers. In this study, different approaches for linear and nonlinear modeling of the shear walls in structural analyses of buildings are studied and applied to RC building with shear walls. The analyses results of different approaches are compared in terms of overall behavior of the structural systems.

LINEAR MODELS FOR SHEARWALLS

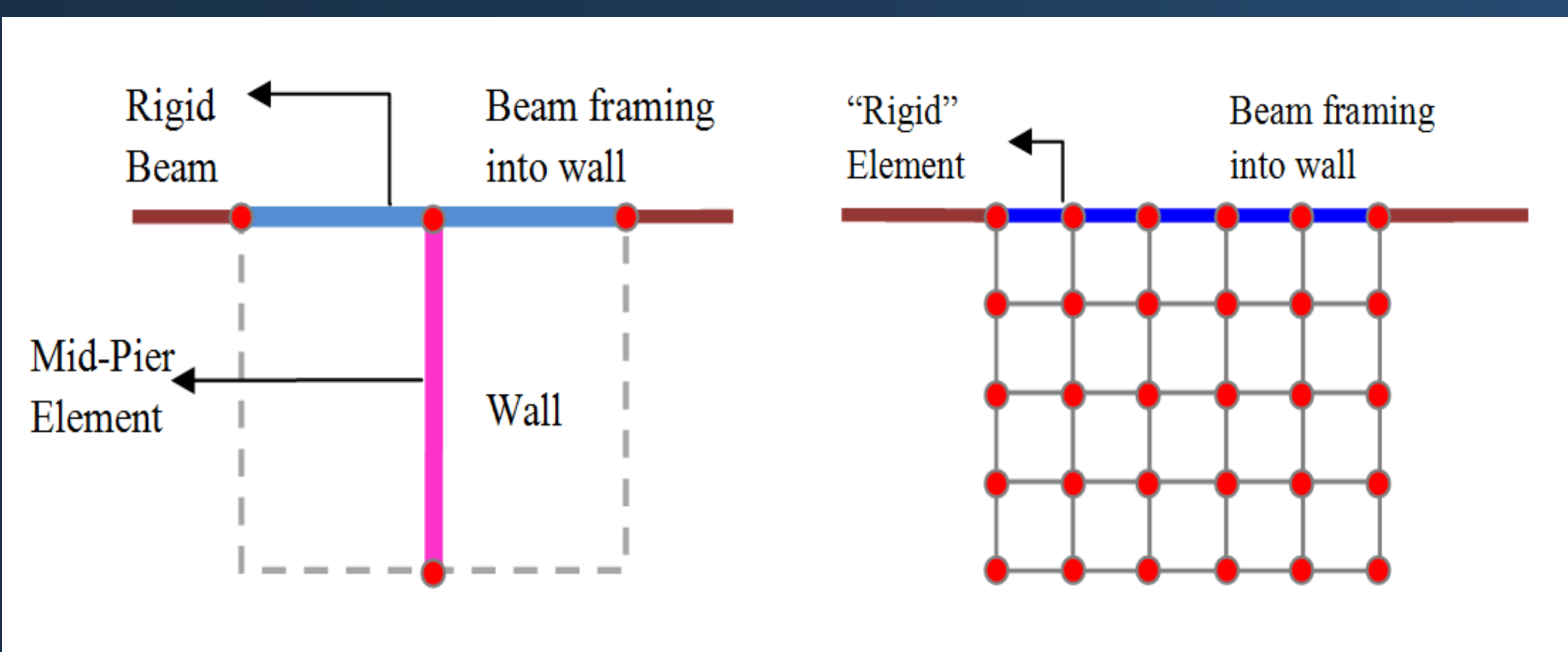

Mid-Pier Frame Model

Shell Element Model

NONLINEAR MATERIAL MODELS FOR SHEAR WALLS

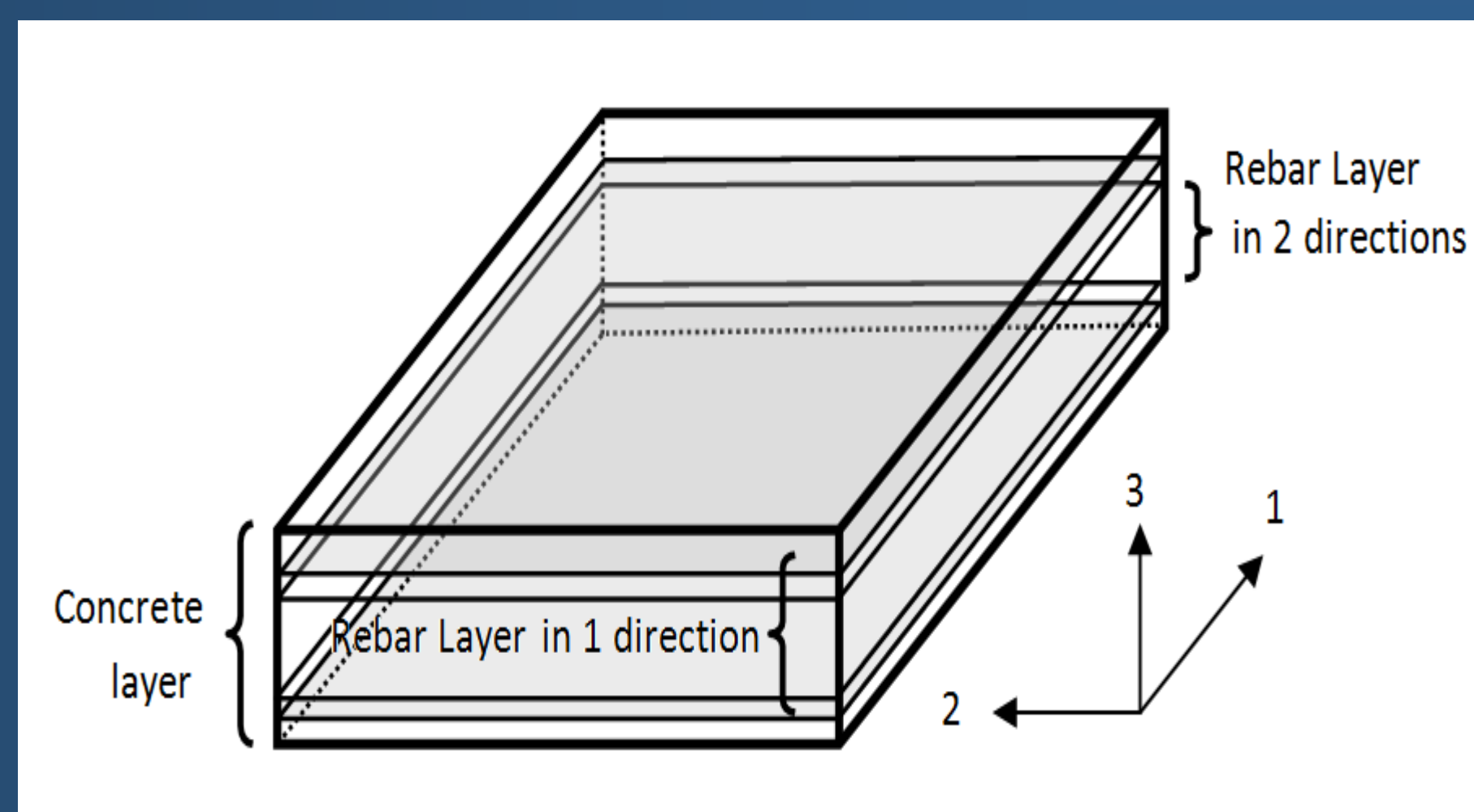

Multi-Layer Shell Element

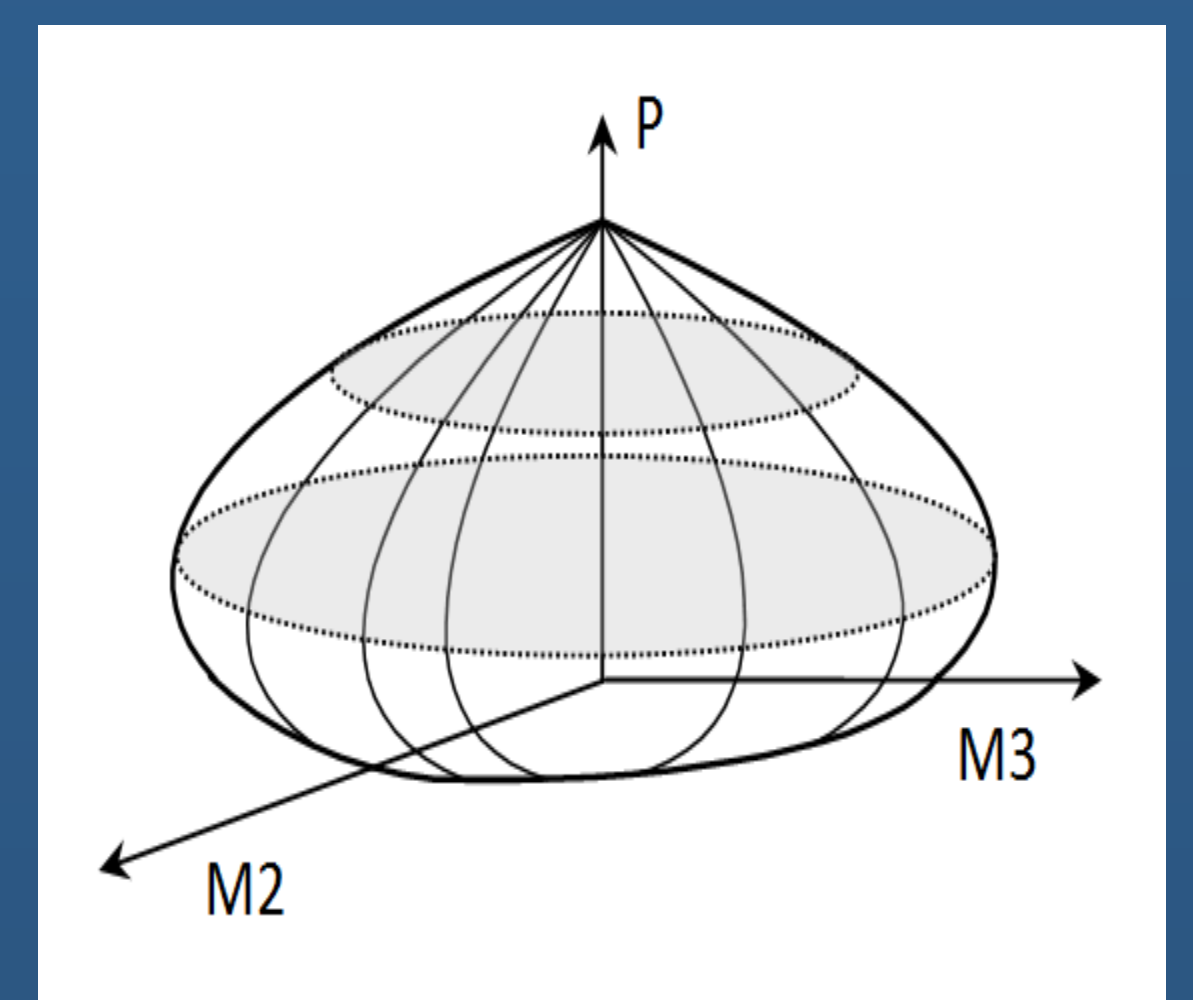

Frame Element Plastic (P-M-M Interaction) Hinge

NUMERICAL EXAMPLES

The structure is an existing school building. The building has five 3.5m high storeys. Concrete grade C14 is used for structural members. Modulus of elasticity value is used as 2.6×10^7 kN/m². Slab loads composed of self weight (G) and the live load (Q), where, $G = \text{own weight} + 1$ kN/m², $Q = 3.5$ kN/m². Probrina Orion (2010), structural analysis and design software is utilized for three dimensional modeling and analyses of the example building.

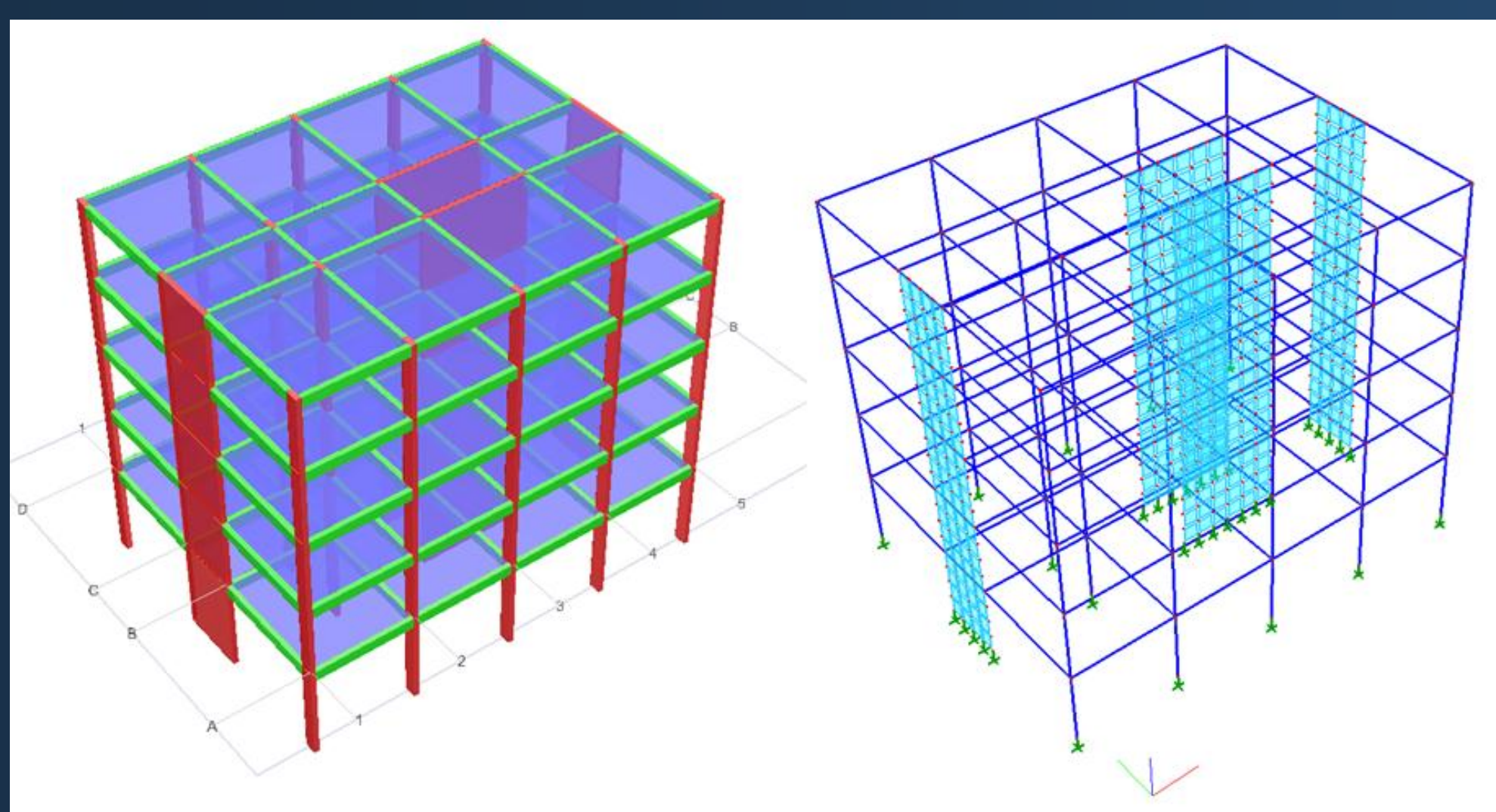

Three dimensional physical and analytical model of the example building

Columns (mm)	250x600	Longitudinal Rebars: 8φ14 Confinement: φ8/20
Walls (mm)	3250x250 5250x250	Longitudinal Rebars: φ12/20 Transverse Rebars: φ12/20
Beams (mm)	250x500	Top Reinforcement %0.8, bottom Reinforcement %0.4
Slab Thickness (mm)	120	

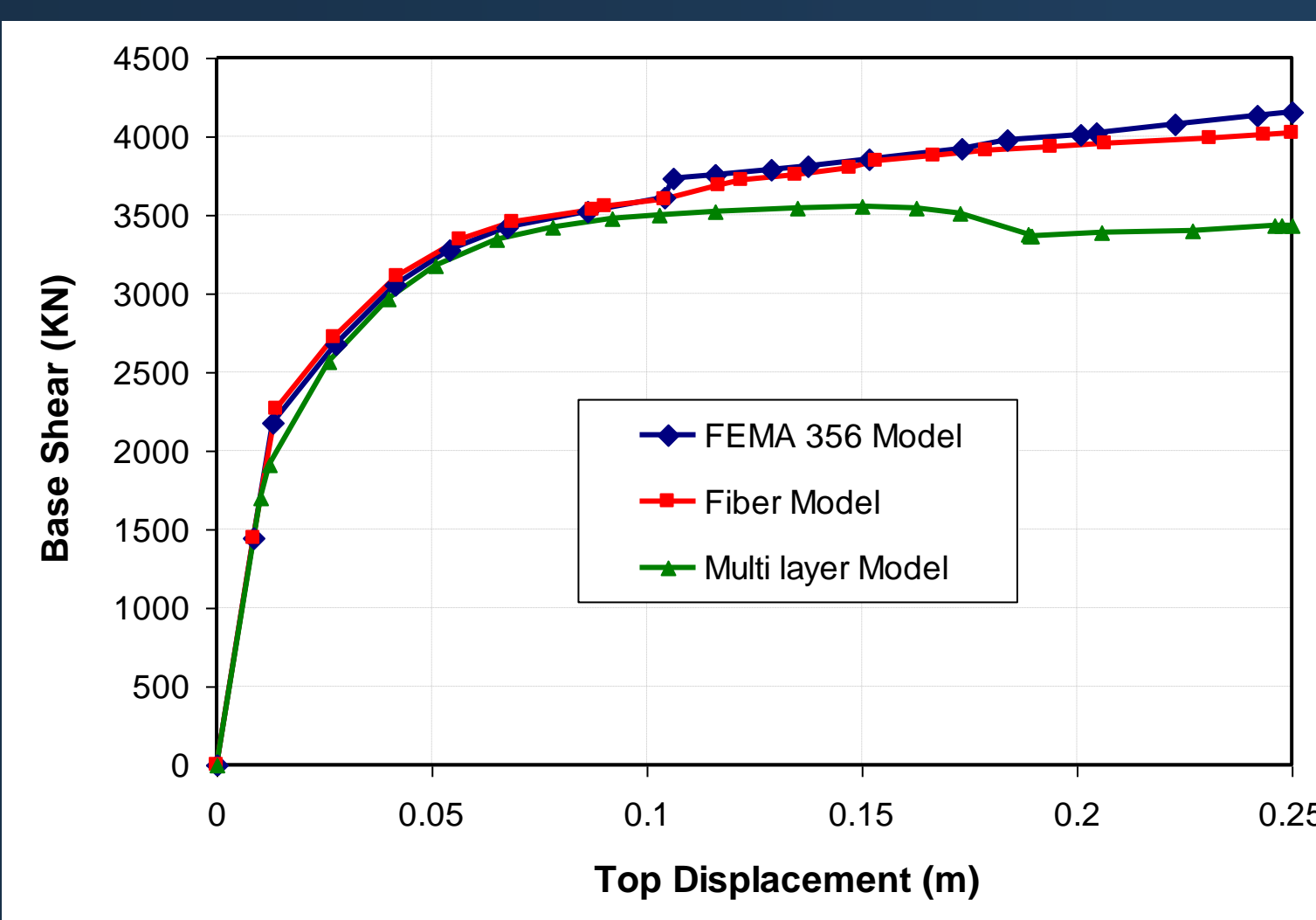

Pushover curves

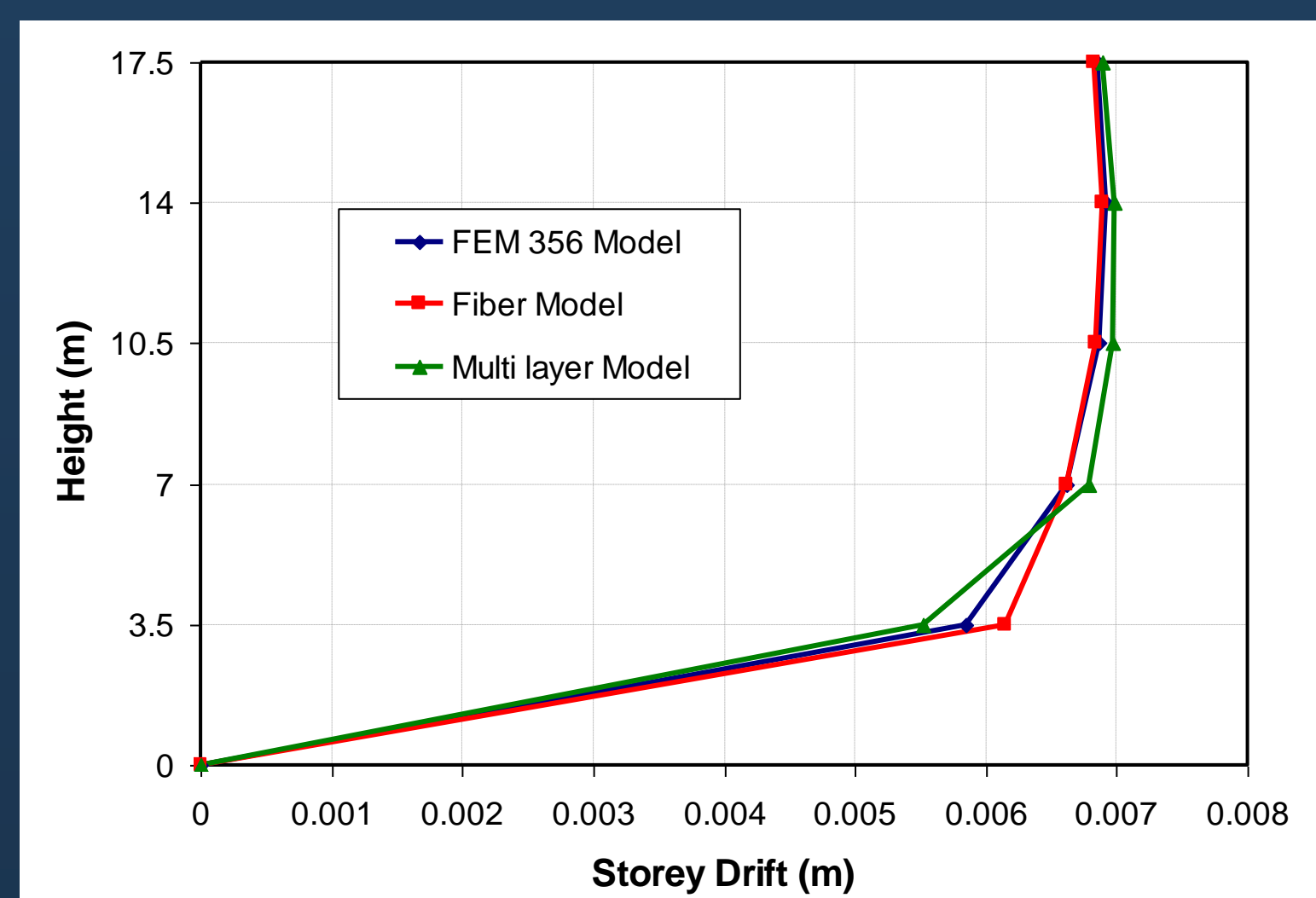

Inter-storey drift ratios

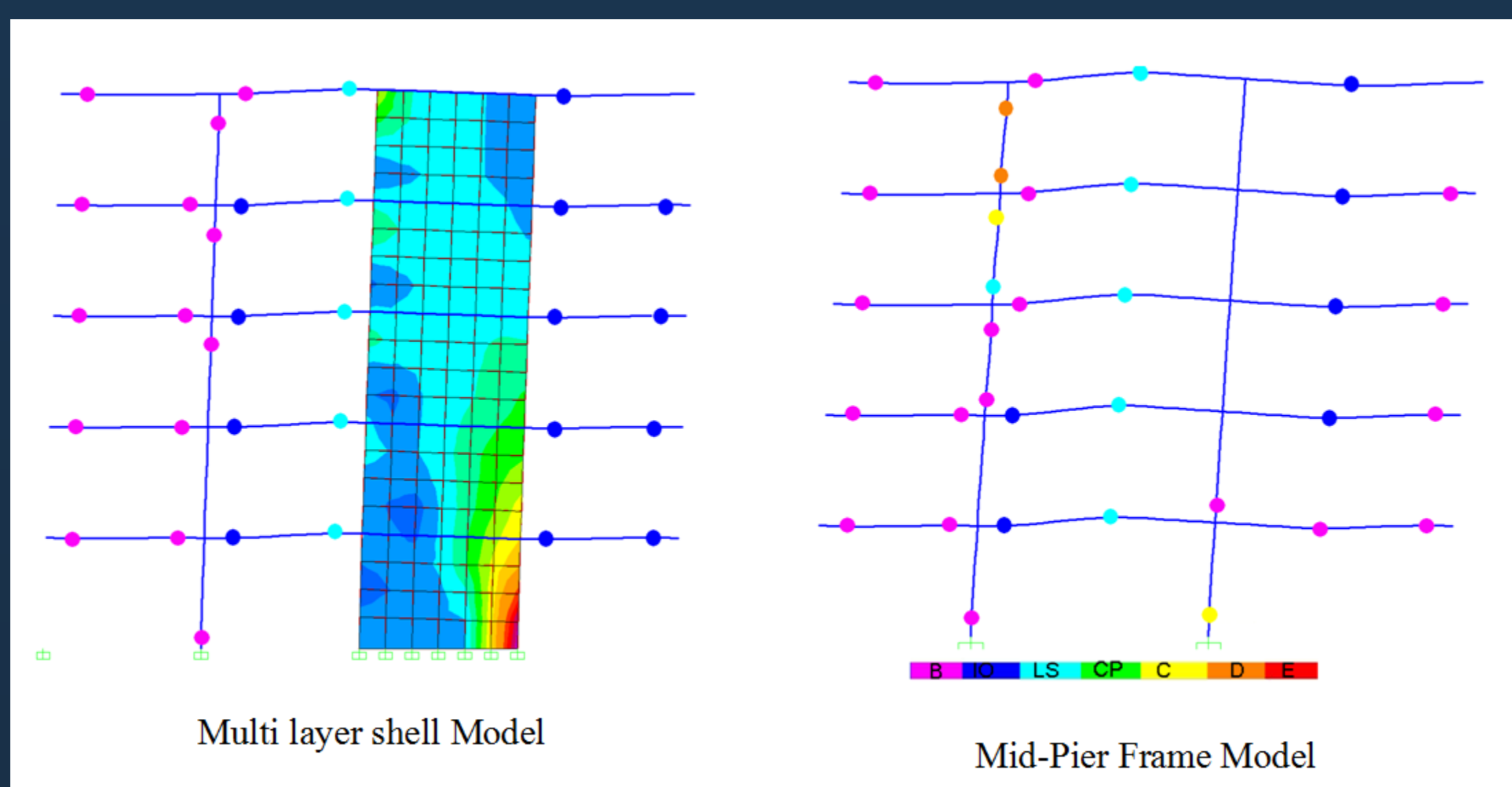

Plastic hinge status at performance point

DISCUSSIONS AND CONCLUSION

- The shear wall with two layers of longitudinal and transverse reinforcement bars could be modeled with different techniques to account for the RC material nonlinearity (multi layer shell and Mid-Pier frame with plastic hinges).
- The pushover analysis for FEMA 356 model and Fiber model produce identical top displacement-Base shear curves for the example building. These curves are approximately the same as curve generated using multi layer shell model for the first 0.1 m of the incremental analysis. FEMA 356 and Fiber models overestimate the capacity of the structure for incremental displacement greater than 0.1m in comparison with multi layer shell model.
- Considering that the performance point of the example building is equal to 0.107 m where the pushover curves of the three models are approximately identical, the inter-storey drift ratios are identical for the three models.
- The distribution and the status of the plastic hinges for three models at the performance point exhibits almost the same pattern.
- Although, the nonlinear behavior of multi layer shell can be examined by checking out the stresses in concrete and reinforcement layers, ACI 40 and FEMA 356 plastic rotations performance levels can not be applied. For the cases where the wall or wall segment behavior is governed by shear, shear drift ratio can be used as the deformation measure as defined in ATC-40.